

Clarke®



18V CORDLESS DRILL

MODEL NO: CON18LiC

PART NO: 6479531

OPERATION & MAINTENANCE INSTRUCTIONS



ORIGINAL INSTRUCTIONS

DL0822 - ISSUE 4

INTRODUCTION

Thank you for purchasing this CLARKE Cordless Drill.

Before attempting to use this product, please read this manual thoroughly and follow the instructions carefully. In doing so you will ensure the safety of yourself and that of others around you, and you can look forward to your purchase giving you long and satisfactory service.

GUARANTEE

This product is guaranteed against faulty manufacture for a period of 12 months from the date of purchase. Please keep your receipt which will be required as proof of purchase.

This guarantee is invalid if the product is found to have been abused or tampered with in any way, or not used for the purpose for which it was intended.

Faulty goods should be returned to their place of purchase, no product can be returned to us without prior permission.

This guarantee does not effect your statutory rights.

ENVIRONMENTAL PROTECTION



Recycle unwanted materials instead of disposing of them as waste. All tools, accessories and packaging should be sorted, taken to a recycling centre and disposed of in a manner which is compatible with the environment.

CARTON CONTENTS

The following items should be supplied in the carton. If any parts are missing or damaged, please see your Clarke dealer.

1 x 18 Volt Cordless Drill

1 x Battery Charger

2 x Li-Ion Battery Packs

SAFETY PRECAUTIONS



WARNING: READ ALL INSTRUCTIONS. FAILURE TO FOLLOW ALL INSTRUCTIONS LISTED BELOW MAY RESULT IN ELECTRIC SHOCK, FIRE AND/OR SERIOUS INJURY. THE TERM "POWER TOOL" IN ALL WARNINGS LISTED BELOW REFERS TO YOUR 18V CORDLESS DRILL.

WORK AREA

1. **Keep work area clean and well lit.** *Cluttered and dark areas invite accidents.*
2. **Do not operate power tools in explosive atmospheres, such as in the presence of flammable liquids, gases or dust.** *Power tools create sparks which may ignite the dust or fumes.*
3. **Keep children and bystanders away while operating a power tool.** *Distractions can cause you to lose control.*

ELECTRICAL SAFETY

1. **Avoid body contact with earthed or grounded surfaces such as pipes, radiators, ranges or refrigerators.** *There is an increased risk of electric shock if your body is earthed or grounded.*
2. **Do not expose power tools to rain or wet conditions.** *Water entering a power tool will increase the risk of electric shock.*
3. **When operating a power tool outdoors, use an extension cord suitable for outdoor use.** *Use of a cord suitable for outdoor use reduces the risk of electric shock.*

PERSONAL SAFETY

1. **Stay alert, watch what you are doing and use common sense when operating a power tool. Do not use a power tool while you are tired or under the influence of drugs, alcohol or medication.** *A moment of inattention while operating power tools may result in personal injury.*
2. **Use safety equipment. Always wear eye protection.** *Safety equipment such as dust mask, non-skid safety shoes, or hearing protection used for appropriate conditions will reduce personal injuries.*
3. **Avoid accidental starting. Ensure the switch is in the off position before connecting to the power supply.**
4. **Do not overreach. Keep proper footing and balance at all times.** *This enables better control of the power tool in unexpected situations.*

5. **Dress properly. Do not wear loose clothing or jewellery. Keep your hair, clothing and gloves away from moving parts.** *Loose clothes, jewellery or long hair can be caught in moving parts.*

POWER TOOL USE AND CARE

1. **Do not force the power tool. Use the correct power tool for your application.** *The correct power tool will do the job better and safer at the rate which it was designed.*
2. **Do not use the power tool if the switch does not turn it on and off.** *Any power tool that cannot be controlled with the switch is dangerous and must be repaired.*
3. **Disconnect the battery before making any adjustments, changing accessories, or storing power tools.** *Such preventive safety measures reduce the risk of starting the power tool accidentally.*
4. **Store idle tools out of the reach of children and do not allow persons unfamiliar with the power tool or these instructions to operate the power tool.** *Power tools are dangerous in the hands of untrained users.*
5. **Maintain power tools. Check for misalignment or binding of moving parts, breakage of parts and any other condition that may affect the power tools operation. If damaged, have the power tool repaired before use.** *Many accidents are caused by poorly maintained power tools.*
6. **Keep cutting tools sharp and clean.** *Correctly maintained cutting tools with sharp cutting edges are less likely to bind and are easier to control.*
7. **Use the power tool and accessories in accordance with these instructions and in the manner intended for the particular type of power tool, taking into account the working conditions and the work to be performed.** *Use of the power tool for operations different from intended could result in a hazardous situation.*

BATTERY TOOL USE AND CARE





1. **Recharge only with the charger specified by the manufacturer.** *A charger that is suitable for one type of battery pack may create a risk of fire when used with another battery pack.*
2. **Use power tools only with specifically designated battery packs.** *Use of any other battery packs may create a risk of injury and fire.*
3. **When battery pack is not in use, keep it away from other metal objects, like paper clips, coins, keys, nails, screws or other small metal objects, that can make a connection from one terminal to another.** *Shorting the battery terminals together may cause burns or a fire.*
4. **Under abusive conditions, liquid may be lost from the battery; avoid contact.** *If contact accidentally occurs, flush with water. If liquid contacts*

eyes, additionally seek medical help. Liquid ejected from the battery may cause irritation or burns.

SERVICE

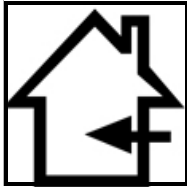
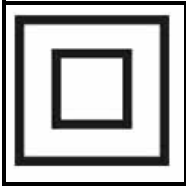
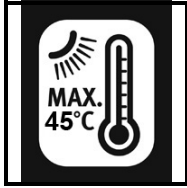
1. **Have your power tool serviced by a qualified repair person using only identical replacement parts.** This will ensure that the safety of the power tool is maintained.

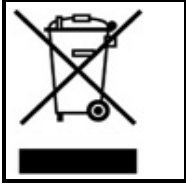
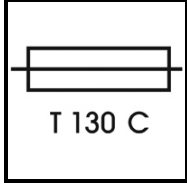
SAFETY SYMBOLS

	Read instruction manual before use		Indoor Use Only
	Class 2 Double Insulated		Maximum Temperature
	Do not immerse in water		Do not Incinerate
	Weee Symbol (lithium ion batteries)		Thermal Fuse Fitted
	Isolating Transformer		

ELECTRICAL CONNECTIONS



WARNING! Read these electrical safety instructions thoroughly before connecting the product to the mains supply.

This product battery charger is provided with a standard 13 amp, 230 volt (50Hz), BS 1363 plug, for connection to a standard, domestic electrical supply. Should the plug need changing at any time, ensure that a plug of identical specification is used.



**WARNING! The wires in the power cable of this product are coloured in accordance with the following code:
Blue = Neutral Brown = Live**

If the colours of the wires in the power cable of this product do not correspond with the markings on the terminals of your plug, proceed as follows.

- The wire which is coloured **Blue** must be connected to the terminal which is marked **N** or coloured **Black**.
- The wire which is coloured **Brown** must be connected to the terminal which is marked **L** or coloured **Red**.

Plug must be BS1363/A approved.

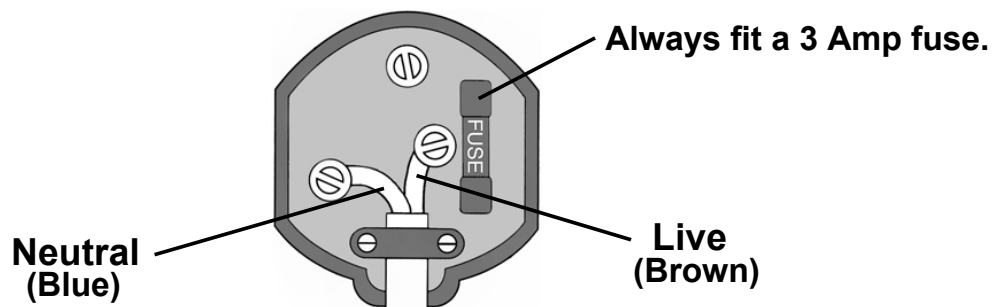

Ensure that the outer sheath of the cable is firmly held by the clamp

We strongly recommend that this machine is connected to the mains supply via a Residual Current Device (RCD)

If in any doubt, consult a qualified electrician. DO NOT attempt any repairs yourself.



This symbol indicates that this is a Class II product, and does not require an earth connection.

BATTERY CHARGING



WARNING: WHEN THE BATTERY IS REMOVED FROM THE DRILL AFTER USE, IT MAY BE HOT. ALWAYS ALLOW IT TO COOL BEFORE RECHARGING. DO NOT RECHARGE A HOT BATTERY.

- The battery pack must be charged before operating the drill.
- The battery should be charged at ambient air temperatures of between -10°C and 45°C.

To charge the battery pack, proceed as follows.

1. Connect the charger to the mains supply.

- The green power indicator will light up.

2. Slide the battery onto the battery charger.

- The green power indicator will stay on and the red charging LED will start flashing while charging is in progress.
- When the battery is fully charged, both the red and green LEDs will be on.
- If both LEDs are flashing rapidly the battery pack has become too hot or is defective.

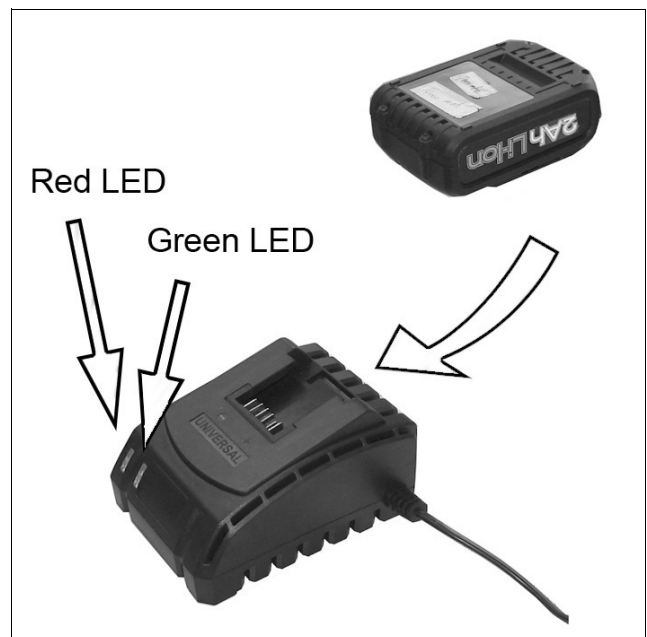

3. Switch off the charger at the mains and remove the battery.

NOTE: Whilst charging, the battery pack and charger may become warm. This is normal and can be expected.

BEFORE USE

FITTING THE BATTERY

FIT THE BATTERY

1. Slide the battery pack onto the base of the handle.



REMOVE THE BATTERY

1. Press and hold the release button on top of the battery.
2. Slide the battery away from the base of the handle.



INSERTING DRILL OR SCREWDRIVER BITS



WARNING: BEFORE REMOVING ANY BITS, MAKE SURE THAT THE FORWARD/REVERSE SWITCH IS IN THE CENTRAL LOCKED OFF POSITION.

1. Grip the chuck collar and rotate the front of the chuck in an anti-clockwise direction.
2. Place the bit in the jaws as far as it will go.
3. Grip the chuck collar and rotate the chuck sleeve in a clockwise direction until it grips the bit tightly.

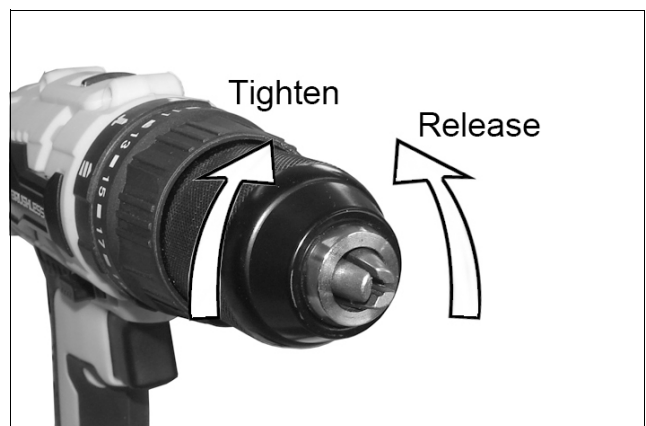

ADJUSTMENTS

FORWARD/REVERSE OPERATION

The forward/reverse switch is used to select the direction of rotation.

1. Use the forward/reverse switch to select the direction of rotation.
2. Reverse should only be selected when removing screws.

SAFETY LOCK OFF

The forward/reverse switch can be used as the safety lock off button by pushing it half way through the drill body.

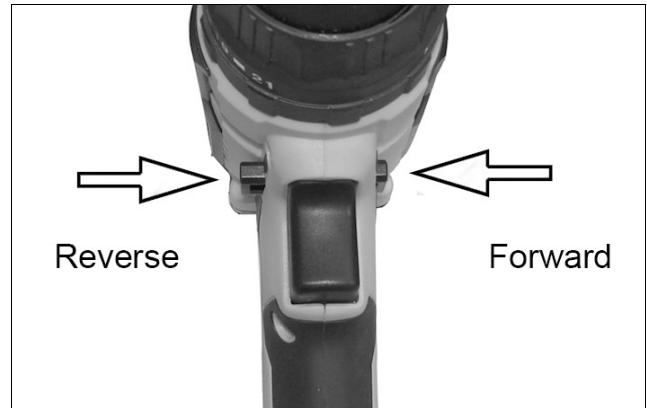

WARNING: ALWAYS LOCK THE TRIGGER SWITCH IN THE OFF (CENTRAL) POSITION WHEN THE DRILL IS NOT BEING USED OR ADJUSTMENTS ARE BEING MADE TO THE SPEED OR TORQUE SETTINGS. THIS IS AN IMPORTANT SAFETY FEATURE AND MUST BE OBSERVED.

SPEED RANGE

Use the speed range selector to select the range you want to use.

- Setting 1: - 0-400 rpm
- Setting 2: - 0-1500 rpm

NOTE: Only use the speed range selector when the chuck is stationary.

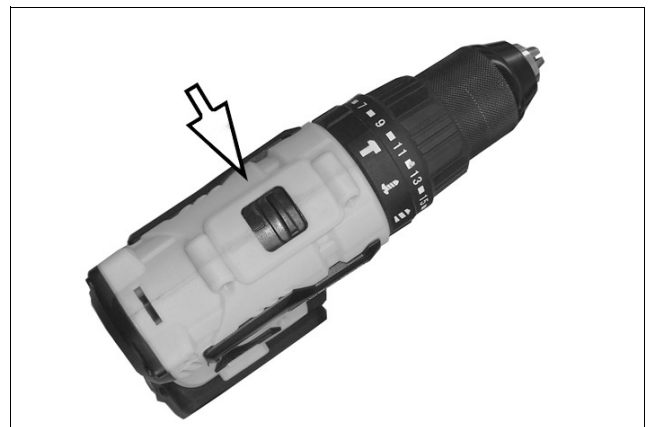

SELECTING THE DRILLING MODE



WARNING: DO NOT CHANGE THE DRILLING MODE WHILE THE CHUCK IS ROTATING.

The drill is equipped with three operating modes.



Hammer drilling mode



Rotary drill mode



Screwdriver mode



CAUTION: WHEN IN THE HAMMER DRILLING MODE YOU SHOULD ONLY USE MASONRY DRILL BITS (NOT SUPPLIED).

To select either hammer, rotary drilling, or screwdriver action mode, rotate the mode selector collar until the appropriate symbol is aligned with the arrow on the machine casing.

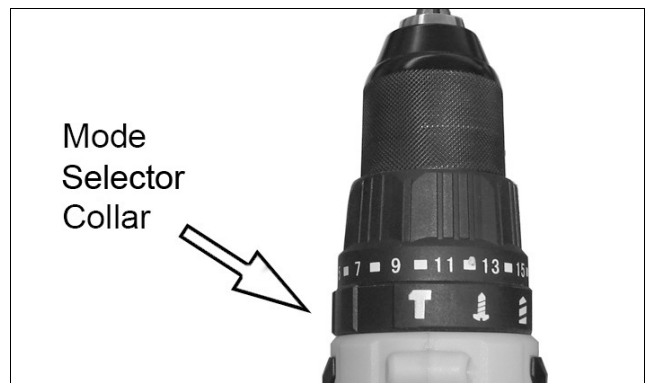

CAUTION: NEVER USE THE HAMMER MODE FOR DRILLING MATERIALS OTHER THAN CONCRETE AND MASONRY.

TORQUE ADJUSTMENT (SCREWDRIVER MODE ONLY)

To select the correct torque setting for screwdriver operation:

1. Set the torque selector to 1.
2. Fit and tighten the first screw.
3. If the clutch starts to ratchet before the screw is correctly seated, rotate the torque adjustment collar to a higher number until the clutch ratchets only when the head of the screw is flush with the surface of the workpiece.

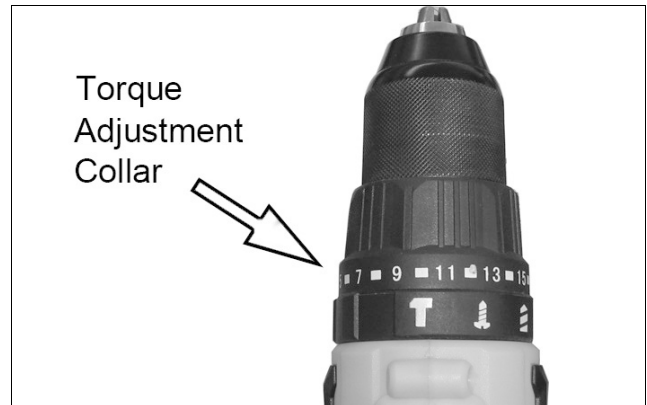

CAUTION: DO NOT ADJUST THE TORQUE ADJUSTMENT COLLAR WHILE THE CHUCK IS ROTATING.

OPERATING THE DRILL

1. Make sure that the forward/reverse switch is positioned in either the forward, or reverse position. See page 9.

NOTE: The trigger will not operate if the direction control switch is in the central position.

2. Squeeze the trigger.
 - The drill will start.
 - The speed can be increased by increasing the pressure on the trigger up to the maximum speed (Setting 1 - 400 rpm, Setting 2 - 1500 rpm).
3. Release the trigger to stop the drill.

DRILLING TIPS

- Always use sharp, good quality drill bits. The performance of your drill is dependant on the quality of the bits used.
- After drilling material to the full depth, do not simply pull out the drill but maintain chuck rotation to ease withdrawal.
- Reduce the pressure on the drill bit when it is about to break through. This will prevent the drill from jamming.
- If drilling a large hole, first drill a pilot hole using a smaller drill bit.
- Always apply pressure to your drill bit in a straight line and, where possible, at right angles to the workpiece.
- When drilling holes or driving screws into walls, floors etc., always make sure that there are no live electrical wires in the path of the bit.
- When drilling in metal, the materials being drilled can become hot. To reduce overheating use a suitable cooling lubricant. No cooling lubricant is necessary when drilling cast iron or brass as they should be drilled dry.
- When drilling metal, the harder the metal the slower the drill speed. Similarly, the bigger the drill bit the slower the speed.
- To prevent the drill bit from slipping when starting to drill a hole in metal, use a centre punch to make an indentation at the start point.
- Always start drilling at a slow speed to prevent the drill from slipping out of the pop mark or indent, gradually increasing speed until the optimum cutting speed is achieved whilst maintaining a MODERATE pressure ONLY. NEVER force the drill bit into the work. This will overheat the tip and cause it to dull very quickly.
- When drilling in wood, clamp a piece of scrap wood to the underside of the material to avoid splintering.
- Always drill directly in line with the bit. Do not use sideways movement as this may damage the drill or cause the bit to break.
- Large holes should be drilled with wood augers, flat wood bits or hole saws.

SCREWDRIVING TIPS

- Place the screwdriver bit in the head of the screw and apply light pressure to the drill.
- If the screw head is not flush with the material, increase the torque and start again.
- Make sure that the screwdriver bit is inserted straight and upright in the screw head, or the screw may be damaged.
- When driving wood screws, pre-drill pilot holes to make driving easier and to prevent splitting the material.
- Select the forward direction to drive screws in and reverse direction to take them out.
- Ensure that the screwdriver bit used is the correct fit for the screw.

MAINTENANCE AND SERVICING



WARNING: ALWAYS REMEMBER TO POSITION THE DIRECTION CONTROL SWITCH IN THE CENTRAL LOCKED OFF POSITION AND REMOVE THE BATTERY PACK, BEFORE CLEANING THE DRILL.

-
- After use, remove the drill or screwdriver bit, open the chuck jaws and tap the side of the chuck to remove any dust, or chippings etc.
 - Keep the cooling vents clear.
 - Clean the motor housing with a soft cloth.
 - Keep the handle clean and free from oil and grease.
 - Keep the charger clean and free from dust and grease.
 - Worn or damaged parts must be replaced by qualified personnel.
 - There are no user serviceable parts inside the drill.

SPECIFICATIONS

Model Number	CON18LiC
Part Number	6479531
Charger voltage	230V~50Hz
Battery voltage	18 volts (2000 mAh)
Charging time	1.0 hour
Keyless chuck capacity	1.5 mm -13 mm
Torque settings	21
Rated Max Torque	50 Nm
Rated No load speed (variable)	Setting 1 - 0 - 400 RPM (low gear) Setting 2 - 0 - 1500 RPM (high gear)
Maximum Drilling Capacity:	Wood - 25 mm Steel - 10 mm Masonry - 8 mm
Sound Pressure Level	66 dB LpA
Sound Power Level	77 dB LWA
Vibration Level	1.18 m/s ²
Weight	1.5 kg

DECLARATION OF CONFORMITY



Clarke[®]
INTERNATIONAL

Hemnall Street, Epping, Essex CM16 4LG

DECLARATION OF CONFORMITY

This is an important document and should be retained.

We hereby declare that this product(s) complies with the following directive(s):

2014/30/EU *Electromagnetic Compatibility Directive.*

2006/42/EC *Machinery Directive.*

2011/65/EU *Restriction of Hazardous substances.*

2006/66/EC *Battery Directive, amended 2013/56/EU.*

The following standards have been applied to the product(s):

EN 60745-1+A11:2010, EN 60745-2-1:2010, EN 60745-2-2:2010, BS EN 60335-1:2012+A11:2014,

BS EN 62233:2008, BS EN 60335-2-29:2004+2010, EN 55014-1:2006+A1:2009+A2:2011,

EN 55014-2:1997+A1+2008, EN 61000-3-2:2014, EN 61000-3-3:2013.

The technical documentation required to demonstrate that the product(s) meet(s) the requirement(s) of the aforementioned directive(s) has been compiled and is available for inspection by the relevant enforcement authorities.

The CE mark was first applied in: 2016

Product Description: 18 Volt Li-Ion Brushless Cordless Hammer Drill (2 x 2amp).
Model number(s): CON18LIC
Serial / batch Number: N/A
Date of Issue: 14/02/2017.

Signed:

J.A. Clarke
Director

A SELECTION FROM THE VAST RANGE OF

Clarke®

QUALITY PRODUCTS



AIR COMPRESSORS
From DIY to industrial, Plus air tools, spray guns and accessories.

GENERATORS
Prime duty or emergency standby for business, home and leisure.

POWER WASHERS
Hot and cold, electric and engine driven - we have what you need

WELDERS
Mig, Arc, Tig and Spot. From DIY to auto/industrial.

METALWORKING
Drills, grinders and saws for DIY and professional use.

WOODWORKING
Saws, sanders, lathes, mortisers and dust extraction.

HYDRAULICS
Cranes, body repair kits, transmission jacks for all types of workshop use.

WATER PUMPS
Submersible, electric and engine driven for DIY, agriculture and industry.

POWER TOOLS
Angle grinders, cordless drill sets, saws and sanders.

STARTERS/CHARGERS
All sizes for car and commercial use.



PARTS & SERVICE: 0208 988 7400

Parts Enquiries
Parts@clarkeinternational.com

Servicing & Technical Enquiries
Service@clarkeinternational.com

SALES: UK 01992 565333 or Export 00 44 (0)1992 565335

Clarke INTERNATIONAL Hemnall Street, Epping, Essex CM16 4LG
www.clarkeinternational.com